

FILE: J:\ENG\PROD\RB\CD-850RB003

INDUCTANCE	WEIGHT
0.11 mH	225 Lbs

NO.	CHANGE DESCRIPTION	BY	DATE	C'K'D
-----	--------------------	----	------	-------

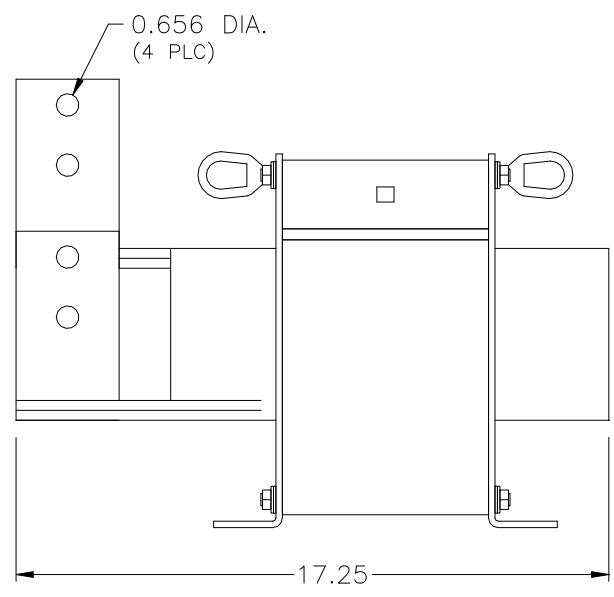
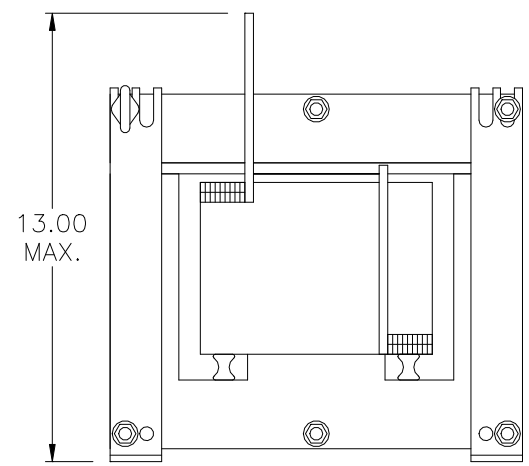
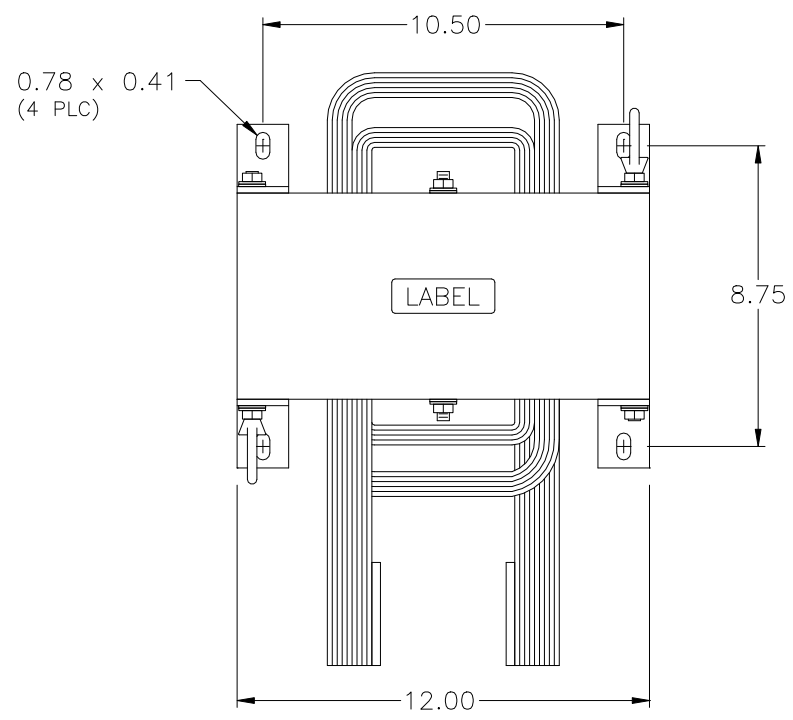

UNLESS OTHERWISE SPECIFIED, DIMENSIONS ARE IN INCHES [mm] AND TOLERANCES ARE:

DECI.	FRAC.
ANGLES	DRILLED HOLES

PART NAME:	DC LINK CHOKE
DESCRIPTION:	OUTLINE DIMENSION
FINISH:	

MTE CORPORATION MENOMONEE FALLS, WISCONSIN			
850RB003			REV. 00
SCALE	NTS	DATE 02/25/05	C'K'D
REF.	DR. BY	KFL	APP'D